

SZ-7510/15/20/25/29/69-P

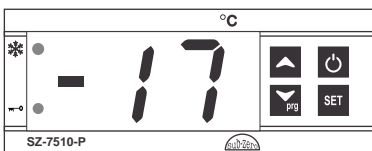

Operating Instructions

SZ-7510-P / SZ-7569-P



SZ-7520-P / SZ-7529-P

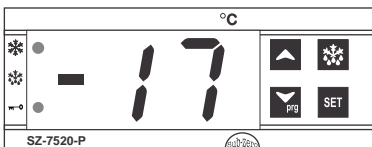

SZ-7515-P

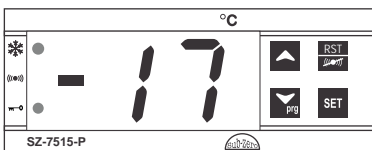

SZ-7525-P

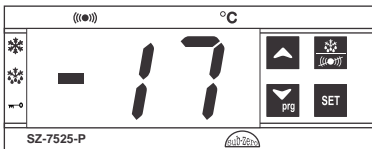

Temperature Controller

Introduction :

The Sub-Zero Series 75XX-P are aesthetically superior versions of their predecessors. The SZ 7515/25-P is a single set point controller with buzzer. The 7520/25-P is a defrost controller, and 7529-P is also a defrost controller with an inbuilt power relay which can drive compressor loads directly upto 20Amps, thereby eliminates contactor in single phase applications. They are specifically designed for refrigeration applications wherein the compressor cuts off at set point and is restarted at a temperature of set point plus differential.

Additionally these controllers offer several protection features that are easily understood by the examples in the instructions below. The controller can be used for heating applications, when the P1 parameter is set to "1" except for SZ-7520/25/29-P.

A number of parameters are displayed alphanumerically to set up the instrument for each specific application.

The SZ-7510/15/20/25/29/69-P controller can be used for several applications with a measuring range from -50°C to 99°C.

CAUTION

WIRING: The probe and its corresponding wires should never be installed in a conduit next to control or power supply lines. The electrical wiring should be done as shown in the diagram. The power supply circuit should be connected to a protection switch. The terminals admit wires of upto 2.5sq mm.

WARNING: Improper wiring may cause irreparable damage and personal injury. Kindly ensure that wiring is done by qualified personnel only.

Maintenance: Cleaning: Clean the surface of the controller with a soft moist cloth. Do not use abrasive detergents, petrol, alcohol or solvents.

Notice: The information in this document is subject to change in order to improve reliability, design or function without prior notice and does not represent a commitment on the part of the company. In no event will the company be liable for direct, indirect, special, incidental or consequential damage arising out of the use or inability to use the product or documentation, even if advised of the possibility of such damages. No part of this manual may be reproduced or transmitted in any form or by any means without the prior written permission of the company.

Installation : Fixing and dimensions of panel models:

To fix the unit, slide the fastener ① through the guides ② as per the position shown in the figure. Move the fastener in the direction of the arrow, pressing tab ③ it permits to move the fastener in the opposite direction of the arrow. Once the controller has been connected, they should be covered with the lid ④ Silicon sealant should be applied along the perimeter of the panel cut out or a rubber 'O' ring supplied before the unit is fitted to increase protection against water seepage.

Controller : Controller should be installed in a place protected by vibration, water and corrosive gasses and where ambient temperature does not exceed the values specified in the technical data.

Probe : To give a correct reading, the probe must be installed in a place protected from thermal influences, which may affect the temperature to be controlled.

Panel Cutout and Dimensions :

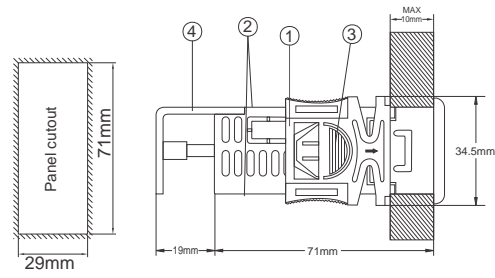

Panel Cutout and Dimensions :

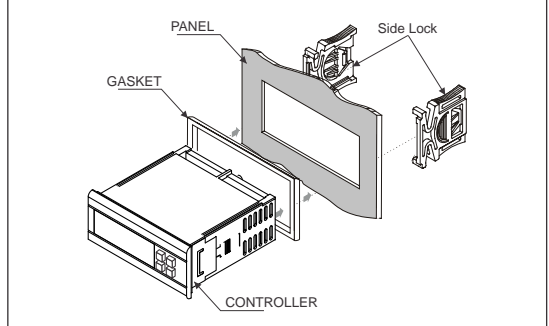

Suggested Wiring SZ-7510/15/20/25-P

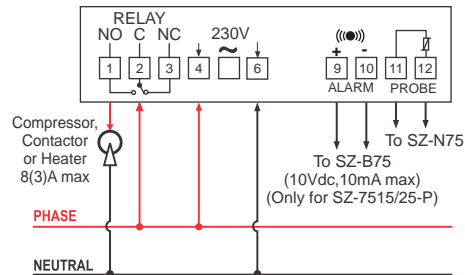

Caution:Wiring for 230Vac load only

Suggested Wiring SZ-7529/69-P

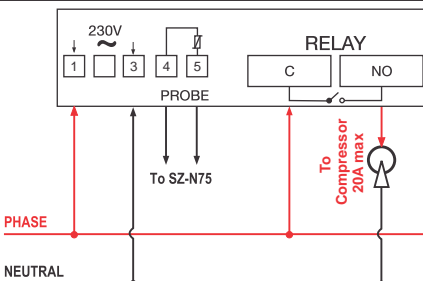

Caution:Wiring for 230Vac load only

Suggested Wiring SZ-7510/15/20/25-P 12VAC/DC

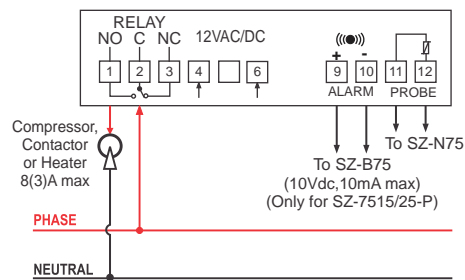

Suggested Wiring SZ-7529/69-P 12VAC/DC

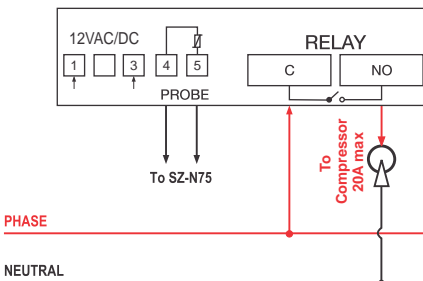

TECHNICAL DATA



Housing	: Black ABS Plastic, Auto-extinguish
Front Cover	: Polycarbonate Plastic
Dimensions	: Frontal : 75 X 34.5mm, Depth : 71mm (w/o back lid)
Panel Cutout	: 29 X 71mm
Mounting	: Flush panel mounting with fasteners
Protection	: IP65 Frontal
Connections	: Screw terminal blocks. ≤ 2.5sq mm terminal only.
Display	: 2 X14.2 mm (0.56") LED
Data storage	: Non-volatile EEPROM memory
Power input	: 230 Vac ±15 % , 50-60Hz. Other on request
Relay output	: 1 SPST relay 20(8)A, 250V AC (for SZ-7569/29-P) 1 SPDT relay 8(3)A, 250V AC (for SZ-7510/15/20/25-P)
Operating temp.	: 5°C to 50°C (non-condensing)
Storage temp	: -20°C to 70°C (non-condensing)
Measuring Range	: -50°C to 99°C
Input	: NTC probe, SZ-N75
Resolution	: +/- 1°C
Accuracy	: +/- 1°C
Probe tolerance at 25°C	: +/- 0.3°C
Alarm (buzzer)	: SZ-B75, 10Vdc, 10mA (only for SZ-7515/25-P)

USER INTERFACE

	UP In Program mode: Scroll through parameters & Increases parameter value. In Set mode : Increases parameter value.
	Down/Program Press and hold for 2sec to enter into program mode. In program mode and set mode: Decreases parameter value
	Stand by Press and hold for 2sec to switch ON / OFF the controller. Also used to exit program mode.
	Set Press and hold for 2sec to enter into set mode. In program mode and set mode: set/save the changed value of parameter.
	Defrost Press & hold for 2 sec to start a manual defrost and to stop Auto / Manual defrost cycle. Only for SZ-7520/29-P Also used to exit program mode.
	Defrost/Mute Press & hold for 2 sec to start a manual defrost and to stop Auto / Manual defrost cycle. Only for SZ-7525-P Also used to exit program mode.
	Reset/Mute This key will mute the buzzer if pressed for 2 seconds. (Only SZ-7515-P) Also used to exit program mode.







INDEX		
Sr. No.	Para.	Description
1	Set Point	Compressor relay set point.
2		Set other parameter.
3	P1	Set Heating or Cooling mode.
4	P2	High temperature limit.
5	P3	Low temperature limit.
6	P4	To set Differential (Hysteresis).
7	P5	Probe calibration.
8	P6	Time Delay (relay restart after cutoff).
9	P7	Defrost duration.
10	P8	Defrost frequency.
11	LP	Keypad Lock
12	FS	Restore factory defaults
13	E1	Compressor relay status in probe fail.
14	PO	Enable / disable Power ON/OFF.
15	AL	Buzzer enable / disable.
16	EP	End Programming
17		LED Indications
18		Operating Messages

Parameter List :

1 Set point	Function: To set the cut out point of the controller. Press and hold the SET key for 2 Seconds. Display will change to set value. The set point value can now be changed by using the UP/DOWN key. After setting the desired value, press the set key and you will see "- -" which confirms that the set point has been stored in memory.
2 To set other Parameters.	Display will flash "P1". To select other parameters, use UP/DOWN keys. Press & hold  key for 2 seconds.
3 P1 Parameter	Function: To set controller for heating or cooling. (Only for SZ-7510/69/15-P) To change value use   keys To set value press SET key 0 = Cooling mode 1 = Heating mode.
4 P2 Parameter	Function: To set maximum allowable high temperature limit. (Buzzer for SZ-7515/25-P) Once set at a particular value, this will not allow the set point to go above this value. Example : Setting this parameter at 25°C will not allow the set point to go above 25°C. Also, if the temperature reaches 25°C, the display will show Ht (High Temp.) indicating that the temperature has gone above the value in this parameter and at this point the buzzer will activate. (if AL parameter is set to 1)

5 P3 Parameter	Function: To set minimum allowable low temperature set point. (Buzzer for SZ-7515/25-P) Once set at a particular value, this will not allow the set point to go below this value. Example : Setting this parameter at -30°C will not allow the set point to go below -30°C. Also, if the temperature reaches -30°C, the display will show Lt (LowTemp.) indicating that the temperature has gone below the value in this parameter and at this point the buzzer will activate.
6 P4 Parameter	Function: To set the differential. Differential between cut out and cut in temperature can be set between 1°C to 20°C. Example (in cooling mode) : If the set point is set at 10°C and differential is set at 2°C, then when the system reaches 10°C, the relay will cut out. Since the differential is 2, the relay will cut in (restart) at 12°C (10°C+2°C).
7 P5 Parameter	Function: To set probe calibration. In time it may be possible that the display may be offset by a degree or so. To compensate for this error, you may need to add or minus the degrees required to achieve the correct temperature. Setting value is from -10°C to +10°C. Example : The temperature on the display is 28°C, whereas the actual temperature is 30°C. You will need to set the P5 mode to 2, which means that once out of the programming mode, the temperature will show 30°C (28°C + 2°C).
8 P6 Parameter	Function: To set time delay between relay restart time. This parameter is used to protect the compressor from restarting in a short period of time and can be set between 0 to 99 minutes. Example : If this parameter is set at 3 minutes, the relay will cut off at the set temperature, but will not restart for a minimum of 3 minutes, even if the differential is achieved earlier. This parameter is good to protect the life of the compressor when there are power fluctuations and the compressor is switched off and on within a few seconds.
9 P7 Parameter	Function : This Parameter is used to set the Duration for Defrost Cycle. (for SZ-7520/25/29-P). This parameter is applicable for both Auto and Manal Defrost and specifies for how much time the Defrost will last. Example : If this parameter is set to 15 Minutes and Defrost Frequency means P8 parameter is set to 1 Hour, then 1 Hour after Power is applied to the controller, defrost will take place for 15 minutes. This Cycle will repeat after every 1 Hour.

10 P8 Parameter	Function : To set the defrost frequency (model SZ-7520/25/29-P) This Parameter is used for auto defrost cycle and specifies, when each defrost cycle will be repeated. Example : see P7 parameter.
11 LP Parameter	Function: To lock keypad. This parameter is used to lock the keypad so that tampering is not possible by by-standers. 0 = keypad unlocked 1 = keypad locked When locked all parameters can only be viewed, but not modified.
12 FS Parameter	Function : To restore default settings of the controller. When set to 1 all parameters are programmed to factory values. Useful to debug setting related problems.
13 E1 Parameter	Function : Compressor relay status in case of Probe Failure. When set to 0 = Relay status is ON. 1 = Relay performs a duty cycle 10 minutes ON and 4 minutes OFF. 2 = Relay status is OFF.
14 PO Parameter	Function : To enable/disable Power Switch. (Only for SZ-7510/69-P) 0 = Disable power switch 1 = Enables power switch Controller has power switch, which if enable puts controller in active or stand by state. If press for 2 seconds controller will go in stand by mode, display will show "OF". To again switch to ACTIVE WORKING MODE, press power switch again for 2 seconds. All leds and 7-segment display will flash and enter into NORMAL WORKING MODE.
15 AL Parameter	Function : To enable / disable buzzer. (Only for 7515/25-P) Once set to 1, the buzzer will be ON incase the temperature reaches or goes above or below the points set in parameter P2 & P3 or if the probe fails. 1 = Enable the buzzer. 0 = Disable the buzzer. Note = Buzzer will be ON in probe fail condition irrespective of AL parameter.
16 EP Parameter	Function: To end programming. To end programming press "SET" key Once the key is pressed, the controller goes into the normal mode and displays the temperature and all settings are recorded.

17 LED INDICATION	
 Compressor ON: Compressor is ON. OFF: Compressor is OFF. FLASHING : Compressor is in time delay.	 Keypad Lock ON: Keypad is lock. OFF: Keypad is unlock.
 Defrost ON: Defrosting is in progress. (Only for SZ-7520/25/29-P)	 Buzzer FLASHING : Buzzer (Ht, Lt or PP) (Only for SZ-7515/25-P)
18 OPERATING MESSAGES	
Ht High temperature alarm Temperature above the maximum high temperature limit.	Lt Low temperature alarm Temperature below the minimum low temperature limit.
PP Probe fail Probe short circuit, circuit open or without probe, or temperature is > 99°C or < -50°C	
Disclaimer: This manual & its contents remain the sole property of A. S. CONTROLS Pvt. Ltd, India and shall not be reproduced or distributed without authorization. Although great care has been taken in the preparation of this document, the company or its vendors in no event will be liable for direct, indirect, special, incidental or consequential damage arising out of the use or inability to use the product or documentation, even if advised of the possibility of such damages. No part of this manual may be reproduced or transmitted in any form or by any means without the prior written permission of the company. A. S. CONTROLS Pvt. Ltd, reserves the right to make and changes or improvements without prior notice.	
Warranty: This product is warranted against defects in materials and workmanship for a period of one year from the date of purchase. During the warranty period, product determined by us to be defective in form or function will be repaired or, at our option, replaced at no charge. This warranty does not apply if the product has been damaged by accident, abuse, and misuse or as a result of service or modification other than by the company. This warranty is in lieu of any other warranty expressed or implied. In no event shall the company be held liable for incidental or consequential damages, including lost revenue or lost business opportunity arising from the purchase of this product.	
OUR OTHER PRODUCTS	
 Controlled cooling, always	
Cold Room Controller Chiller Controller Two Compressor Controller Heating Controller Humidity Controller Pressure Controller	
	
Ball Valves Globe Valves Hand Valves Flow Switches Solenoid Valves	
03 / 17.03.17	

Clean Rooms | Pharma | Hospital | HVAC | BulkDrugs | Chemicals | Heavy Machinery | Hydraulics | Vacuum Industry
Green House | Server Room | Confined Space | Cold Storage

Instrukart Holdings

India Toll Free : 1800-121-0506 | Ph : +91 (40)40262020

Mob +91 7331110506 | Email : info@instrukart.com

#18, Street-1A, Czech Colony, Sanath Nagar, Hyderabad -500018, INDIA.

